

2D 3D DEVELOPMENT

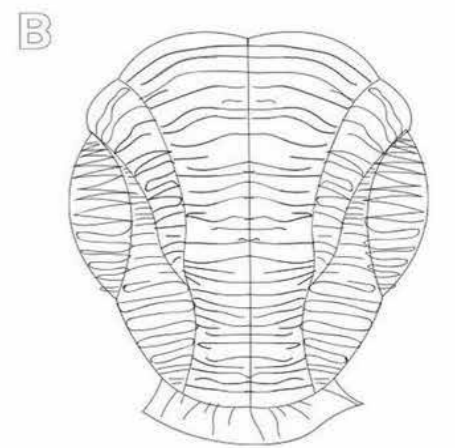

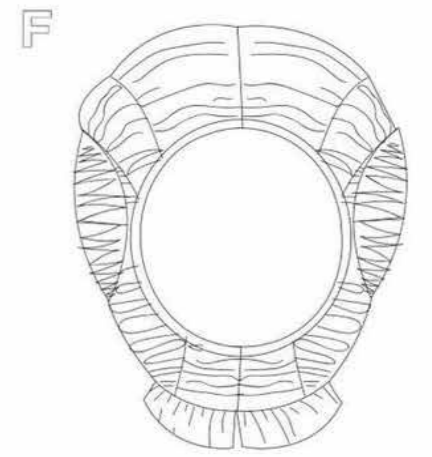

Loosen to wear around neck

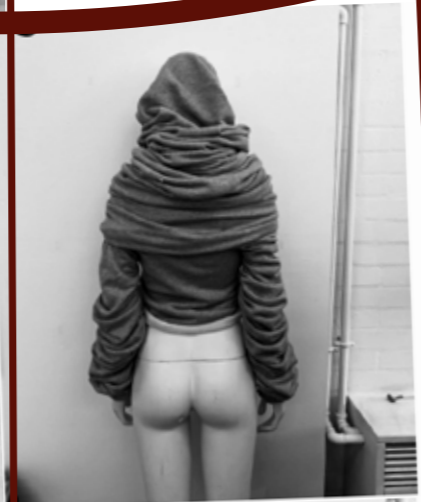

★
KEEP THIS CURVE



LOOK 1



LOOK 1 DEVELOPMENT





LOOK 2 DEVELOPMENT



FINAL TOILE REVIEW



REMOVE DOUBLE PANEL AT BACK + ADD SIMMER PANEL

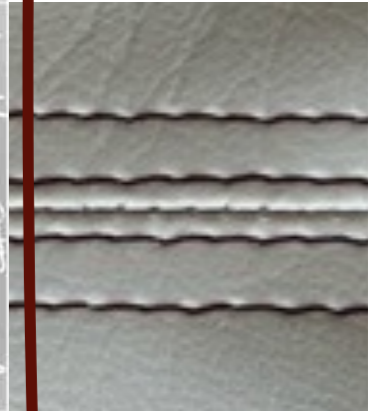
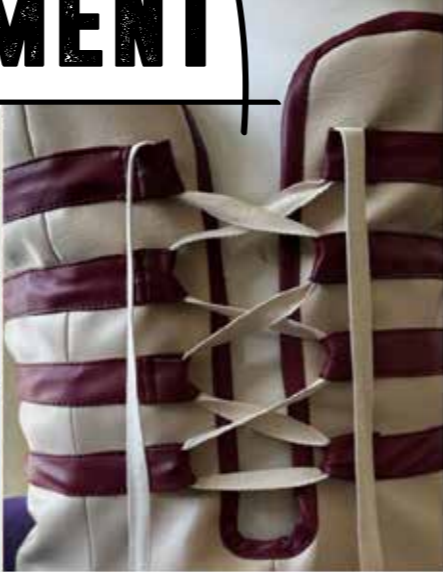

GATHER INSTEAD OF PLEAT 



ROLL DOWN WAIST



LOOK 4 DEVELOPMENT

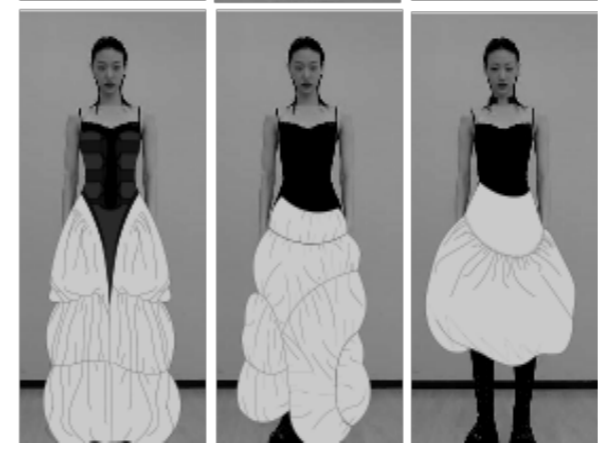
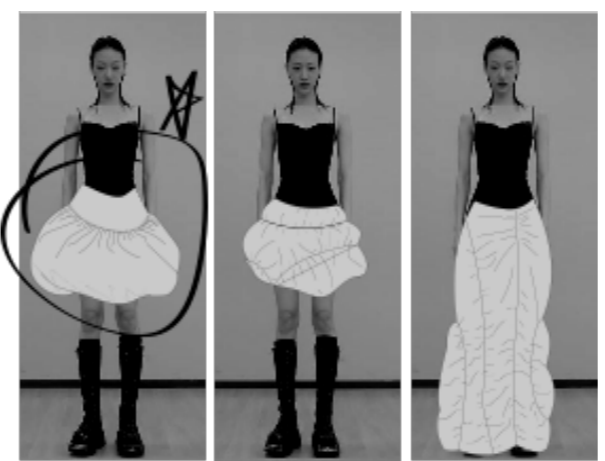

USE DETAILING FOR UNDER-SKIRT

VELCRO STRAP

LOOK AT UPHOLSTERY



WITH CLENCHED FIST



PHOTOGRAPHIC LINE UP



LOOK 2

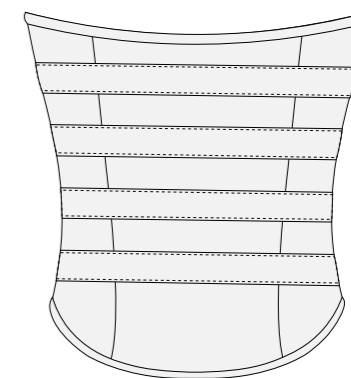
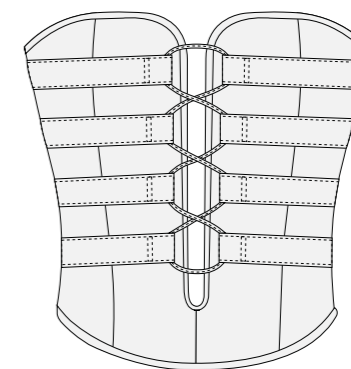
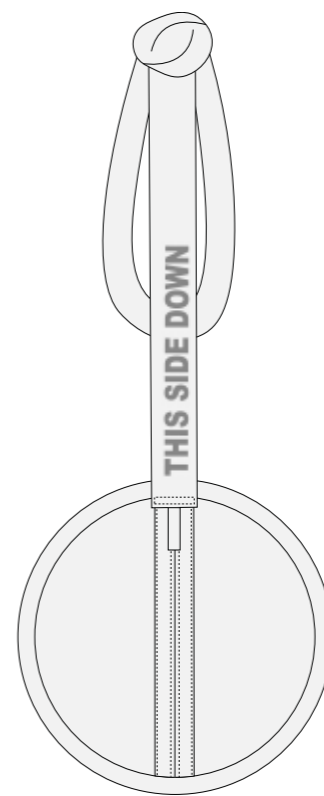
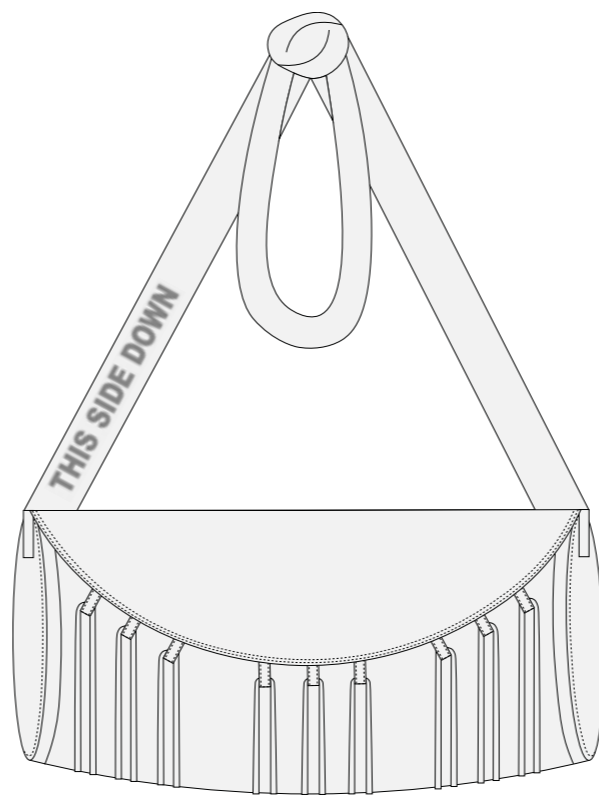
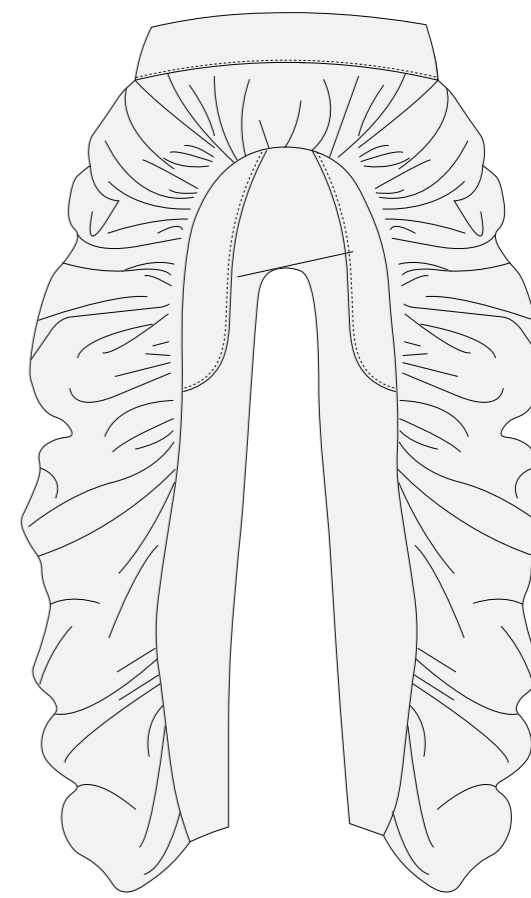
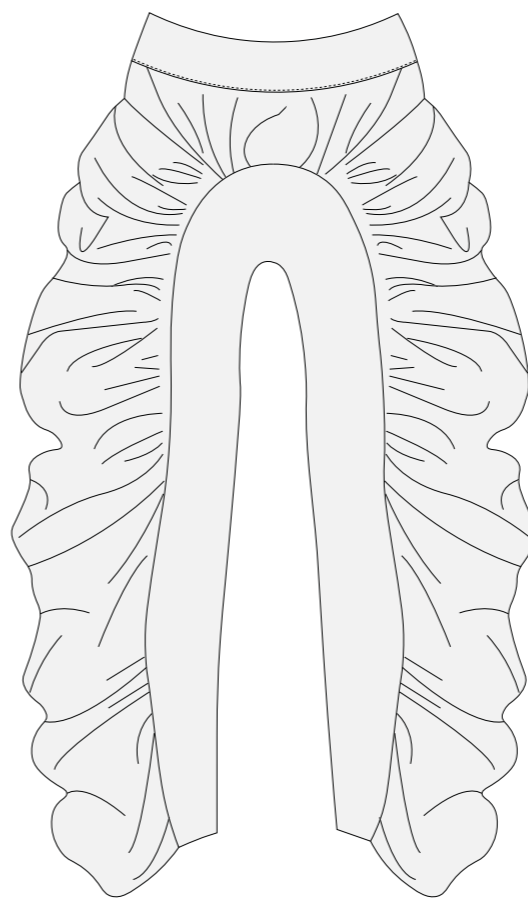
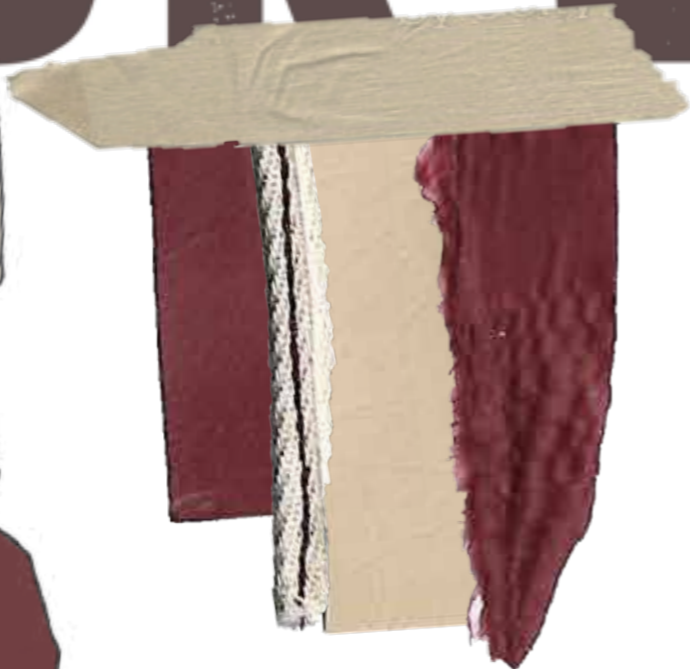

LOOK 4

